

## Illumination Control Fixture Whips - 1/2 Inch

### Product Data Sheet

Our Illumination Control Fixture Whip (ICFW) is an integral component for combining power for illumination and control of all lighting systems. The ICFW can be used in new or retrofit construction for lighting systems operating at 120/277 VAC, meets all UL and NEC standards for combining power and lighting circuits with Class 2 or Class 3 control circuits within the same fixture whip.

The ICFW is easily integrated into the architecture of a building using LED luminaires or fluorescent luminaires with dimming ballast and digital controls to:

- Optimize lighting at all times when used with an independent room controller for daylight harvesting as an energy management solution to reduce energy consumption.
- Operate in compliance with "timed" daily personnel and warehouse schedules.
- Control lighting operations used in combination with occupancy sensors for commercial and industrial applications.

### BENEFITS

- UL Listed. File Number E87199.
- Combines power and lighting circuits with Class 2 or Class 3 control circuits.
- Easy to install and wire, and ready to use right out of the box. Saves time and labor compared to using expensive MC cable or making a solution on the job site.
- Can be used with dimming ballast and digital controls to optimize lighting using daylight harvesting, occupancy sensor, or timing controls.
- Includes two (2) 16 AWG Purple and Pink Jacketed Control Wires.
- Available in stranded or solid wire, and with die cast screw-in, die cast snap-in, or polycarbonate snap-in connectors.
- Meets the requirements of the 2023 National Electrical Code: Articles 300.3(B)(2), (C)(1), Section 725.136(I)(1), and 725.139(A) through (D)(1) and California Title 24 Lighting Controls, Articles 130.1(A)(B)(C)(D)(E).

### WHY IS IT NECESSARY TO USE ILLUMINATION CONTROL FIXTURE WHIPS?

- Wireless Lighting Controls use Relay Modules that can be attached to the outside of an electrical junction box with a nipple.
- The connection(s) of the low voltage conductors from the dimmable ballast or LED driver are intended to go through the Junction Box, and through the nipple and into the Lighting Control Relay Module to receive controller commands.
- When the Contractor wants to use a single pre-fabricated Fixture Whip to control a luminaire with control features.

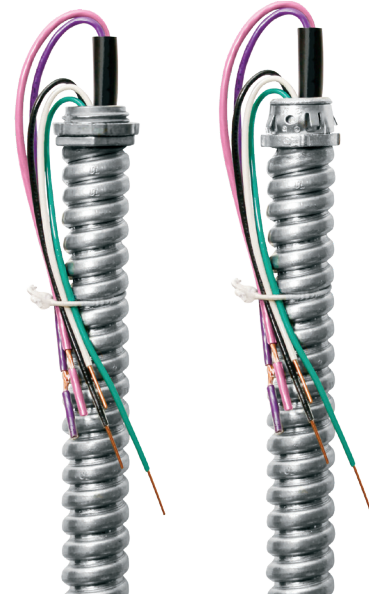

120-Volt, Die Cast Screw-In Connector

277-Volt, Die Cast Snap-In Connector



### Illumination Control Fixture Whip — Dimensions

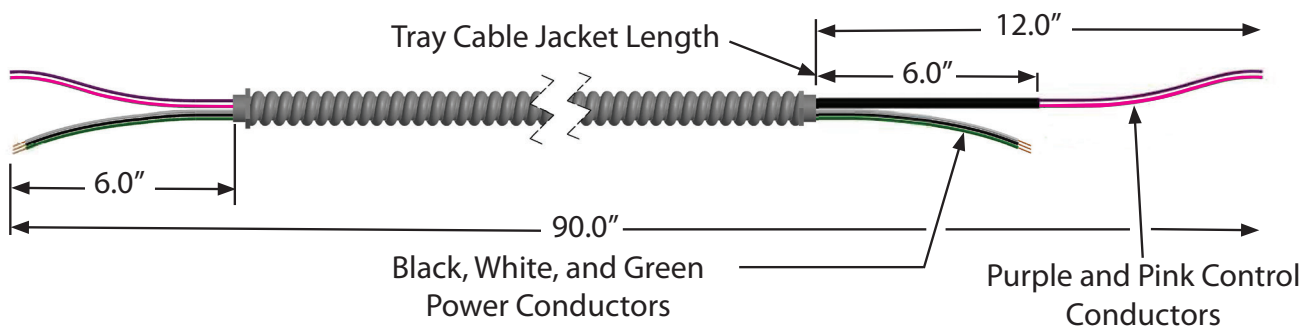

## Illumination Control Fixture Whip — Application Example

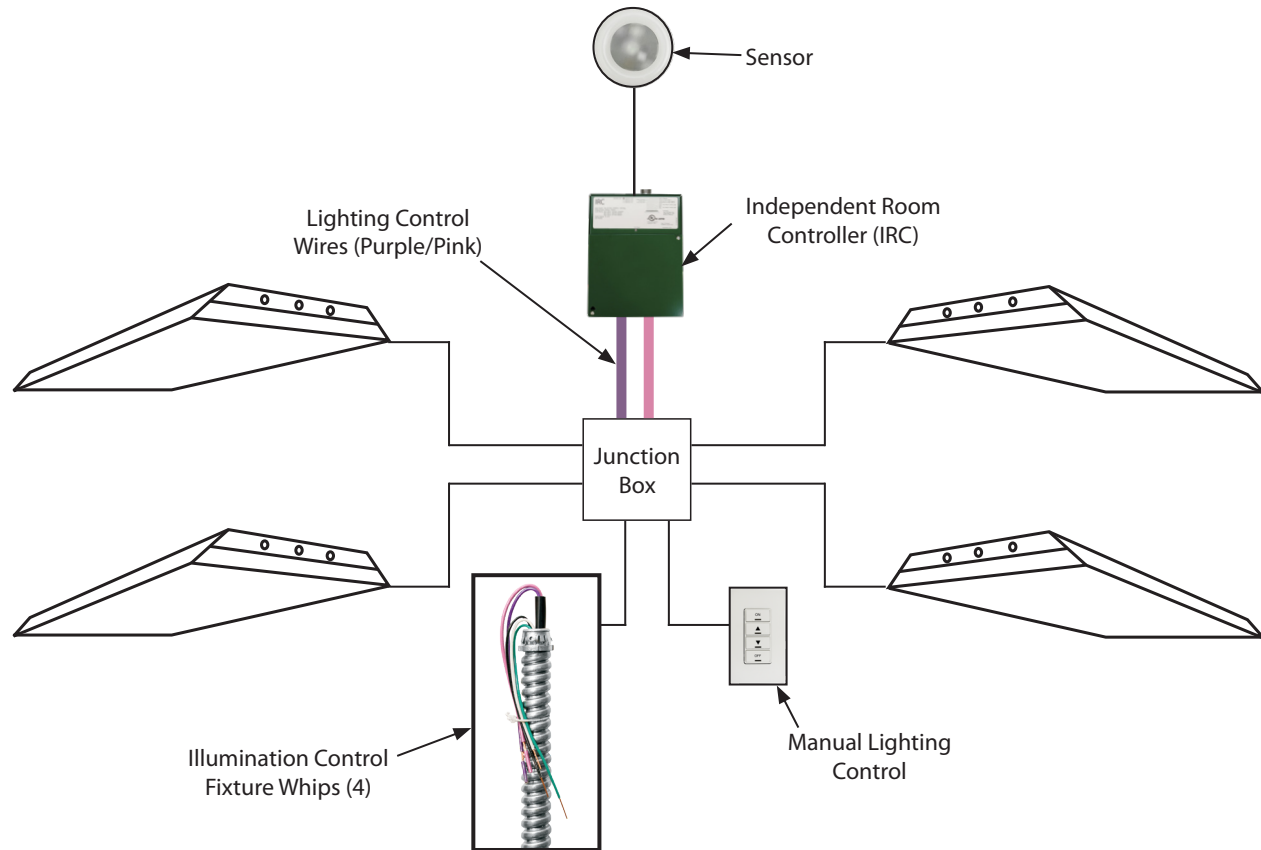

## Illumination Control Fixture Whip — Connector Reference Guide

Common connectors used on pre-made assembly.

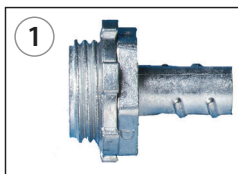

**1**  
**Size:** 1/2": P/N E00-026-000  
**Type:** Screw-in (lock-nut)  
**Material:** Die Cast  
**Insulated:** Yes or No (circle one)

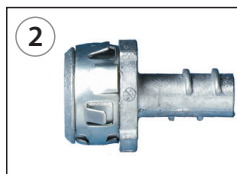

**2**  
**Size:** 1/2": P/N E00-005-000  
**Type:** Screw-in/Snap-in  
**Material:** Die Cast  
**Insulated:** Yes or No (circle one)

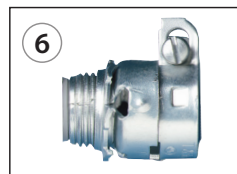

**6**  
**Size:** 1/2": P/N E00-042-002  
**Type:** Set Screw, Squeeze  
**Material:** Steel  
**Insulated:** 3/8": No  
 1/2": Yes

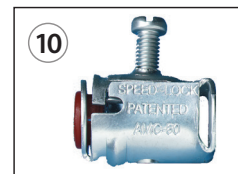

**10**  
**Size:** 1/2": P/N E00-005-002  
**Type:** Speed Lock Style, Snap-in  
**Material:** Steel  
**Insulated:** Yes

# ILLUMINATION CONTROL FIXTURE WHIPS

Catalog Number	UPC Number	Description	Order Unit	Unit Qty	Unit Pkg	Units/Case	TL Case Qty	Min Order Qty	MM Req	Ship Wt (Lbs)
<b>120 Volt Illumination Control Fixture Whips: 6-Foot, Stranded Wire, Die Cast Screw-In Connectors, .5" Conduit</b>										
EPW1263-1/2-IC	84010	3-12 AWG Stranded Wire, 6-FT, Black, White, Green	EA	1	BRL	100	100	10	Yes	292
EPW1463-1/2-IC	84012	3-14 AWG Stranded Wire, 6-FT, Black, White, Green	EA	1	BRL	100	100	10	Yes	282
EPW1464-1/2-IC	84013	4-14 AWG Stranded Wire, 6-FT, Black, Red, White, Green	EA	1	BRL	100	100	10	Yes	282
EPW1663-1/2-IC	84016	3-16 AWG Stranded Wire, 6-FT, Black, White, Green	EA	1	BRL	100	100	10	Yes	277
EPW1664-1/2-IC	84017	4-16 AWG Stranded Wire, 6-FT, Black, Red, White, Green	EA	1	BRL	100	100	10	Yes	272
EPW1863-1/2-IC	84020	3-18 AWG Stranded Wire, 6-FT, Black, White, Green	EA	1	BRL	100	100	10	Yes	270
EPW1864-1/2-IC	84021	4-18 AWG Stranded Wire, 6-FT, Black, Red, White, Green	EA	1	BRL	100	100	10	Yes	277
<b>120 Volt Illumination Control Fixture Whips: 6-Foot, Solid Wire, Die Cast Screw-In Connectors, .5" Conduit</b>										
EPW1263S-1/2-IC	84011	3-12 AWG Solid Wire, 6-FT, Black, White, Green	EA	1	BRL	100	100	10	Yes	292
EPW1463S-1/2-IC	84014	3-14 AWG Solid Wire, 6-FT, Black, White, Green	EA	1	BRL	100	100	10	Yes	282
EPW1464S-1/2-IC	84015	4-14 AWG Solid Wire, 6-FT, Black, Red, White, Green	EA	1	BRL	100	100	10	Yes	282
EPW1663S-1/2-IC	84018	3-16 AWG Solid Wire, 6-FT, Black, White, Green	EA	1	BRL	100	100	10	Yes	277
EPW1664S-1/2-IC	84019	4-16 AWG Solid Wire, 6-FT, Black, Red, White, Green	EA	1	BRL	100	100	10	Yes	272
EPW1863S-1/2-IC	84022	3-18 AWG Solid Wire, 6-FT, Black, White, Green	EA	1	BRL	100	100	10	Yes	270
EPW1864S-1/2-IC	84023	4-18 AWG Solid Wire, 6-FT, Black, Red, White, Green	EA	1	BRL	100	100	10	Yes	277
<b>120 Volt Illumination Control Fixture Whips: 6-Foot, Stranded Wire, Die Cast Snap-In Connectors, .5" Conduit</b>										
EPW1263AD-1/2-IC	84024	3-12 AWG Stranded Wire, 6-FT, Black, White, Green	EA	1	BRL	100	100	10	Yes	292
EPW1463AD-1/2-IC	84026	3-14 AWG Stranded Wire, 6-FT, Black, White, Green	EA	1	BRL	100	100	10	Yes	282
EPW1464AD-1/2-IC	84027	4-14 AWG Stranded Wire, 6-FT, Black, Red, White, Green	EA	1	BRL	100	100	10	Yes	282
EPW1663AD-1/2-IC	84030	3-16 AWG Stranded Wire, 6-FT, Black, White, Green	EA	1	BRL	100	100	10	Yes	277
EPW1664AD-1/2-IC	84031	4-16 AWG Stranded Wire, 6-FT, Black, Red, White, Green	EA	1	BRL	100	100	10	Yes	272
EPW1863AD-1/2-IC	84034	3-18 AWG Stranded Wire, 6-FT, Black, White, Green	EA	1	BRL	100	100	10	Yes	270
EPW1864AD-1/2-IC	84035	4-18 AWG Stranded Wire, 6-FT, Black, Red, White, Green	EA	1	BRL	100	100	10	Yes	277
<b>120 Volt Illumination Control Fixture Whips: 6-Foot, Solid Wire, Die Cast Snap-In Connectors, .5" Conduit</b>										
EPW1263SAD-1/2-IC	84025	3-12 AWG Solid Wire, 6-FT, Black, White, Green	EA	1	BRL	100	100	10	Yes	292
EPW1463SAD-1/2-IC	84028	3-14 AWG Solid Wire, 6-FT, Black, White, Green	EA	1	BRL	100	100	10	Yes	282
EPW1464SAD-1/2-IC	84029	4-14 AWG Solid Wire, 6-FT, Black, Red, White, Green	EA	1	BRL	100	100	10	Yes	282
EPW1663SAD-1/2-IC	84032	3-16 AWG Solid Wire, 6-FT, Black, White, Green	EA	1	BRL	100	100	10	Yes	277
EPW1664SAD-1/2-IC	84033	4-16 AWG Solid Wire, 6-FT, Black, Red, White, Green	EA	1	BRL	100	100	10	Yes	272
EPW1863SAD-1/2-IC	84036	3-18 AWG Solid Wire, 6-FT, Black, White, Green	EA	1	BRL	100	100	10	Yes	270
EPW1864SAD-1/2-IC	84037	4-18 AWG Solid Wire, 6-FT, Black, Red, White, Green	EA	1	BRL	100	100	10	Yes	277

**Note:** All Illumination Control Fixture Whips include two (2) 16 AWG Jacketed Control Wires — Purple and Pink.

**UNITS OF MEASURE KEY** Order Unit: The Unit to be ordered; Unit Qty: Number of pieces in each Unit; Unit Pkg: Unit Packages contained in the case - Packaging types - BG (Bag), BRL (Barrel), BX (Box), BN (Bulk), PKG (Package), EA (Each), RL (Roll), LB (Pound), C (Hundred), M (Thousand); Units/Case: Unit packages contained in the Case; TL Case Qty: The total number of items in each Master Case; Min Order Qty: The smallest Unit that can be ordered; MM Req: Must order multiples of the Unit in the stated quantities; Ship Wt (Lbs): Total weight of the units per Carton

# ILLUMINATION CONTROL FIXTURE WHIPS

Catalog Number	UPC Number	Description	Order Unit	Unit Qty	Unit Pkg	Units/Case	TL Case Qty	Min Order Qty	MM Req	Ship Wt (Lbs)
<b>277 Volt Illumination Control Fixture Whips: 6-Foot, Stranded Wire, Die Cast Screw-In Connectors, .5" Conduit</b>										
EPW1263-1/2-BGG-IC	84038	3-12 AWG Stranded Wire, 6-FT, Brown, Grey, Green	EA	1	BRL	100	100	10	Yes	292
EPW1463-1/2-BGG-IC	84042	3-14 AWG Stranded Wire, 6-FT, Brown, Grey, Green	EA	1	BRL	100	100	10	Yes	282
EPW1464-1/2-BOGG-IC	84046	4-14 AWG Stranded Wire, 6-FT, Brown, Orange, Grey, Green	EA	1	BRL	100	100	10	Yes	282
EPW1663-1/2-BGG-IC	84050	3-16 AWG Stranded Wire, 6-FT, Brown, Grey, Green	EA	1	BRL	100	100	10	Yes	277
EPW1664-1/2-BOGG-IC	84054	4-16 AWG Stranded Wire, 6-FT, Brown, Orange, Grey, Green	EA	1	BRL	100	100	10	Yes	272
EPW1863-1/2-BGG-IC	84058	3-18 AWG Stranded Wire, 6-FT, Brown, Grey, Green	EA	1	BRL	100	100	10	Yes	270
EPW1864-1/2-BOGG-IC	84062	4-18 AWG Stranded Wire, 6-FT, Brown, Orange, Grey, Green	EA	1	BRL	100	100	10	Yes	277
<b>277 Volt Illumination Control Fixture Whips: 6-Foot, Solid Wire, Die Cast Screw-In Connectors, .5" Conduit</b>										
EPW1263S-1/2-BGG-IC	84040	3-12 AWG Solid Wire, 6-FT, Brown, Grey, Green	EA	1	BRL	100	100	10	Yes	292
EPW1463S-1/2-BGG-IC	84044	3-14 AWG Solid Wire, 6-FT, Brown, Grey, Green	EA	1	BRL	100	100	10	Yes	282
EPW1464S-1/2-BOGG-IC	84048	4-14 AWG Solid Wire, 6-FT, Brown, Orange, Grey, Green	EA	1	BRL	100	100	10	Yes	282
EPW1663S-1/2-BGG-IC	84052	3-16 AWG Solid Wire, 6-FT, Brown, Grey, Green	EA	1	BRL	100	100	10	Yes	277
EPW1664S-1/2-BOGG-IC	84056	4-16 AWG Solid Wire, 6-FT, Brown, Orange, Grey, Green	EA	1	BRL	100	100	10	Yes	272
EPW1863S-1/2-BGG-IC	84060	3-18 AWG Solid Wire, 6-FT, Brown, Grey, Green	EA	1	BRL	100	100	10	Yes	270
EPW1864S-1/2-BOGG-IC	84064	4-18 AWG Solid Wire, 6-FT, Brown, Orange, Grey, Green	EA	1	BRL	100	100	10	Yes	277
<b>277 Volt Illumination Control Fixture Whips: 6-Foot, Stranded Wire, Die Cast Snap-In Connectors, .5" Conduit</b>										
EPW1263AD-1/2-BGG-IC	84039	3-12 AWG Stranded Wire, 6-FT, Brown, Grey, Green	EA	1	BRL	100	100	10	Yes	292
EPW1463AD-1/2-BGG-IC	84043	3-14 AWG Stranded Wire, 6-FT, Brown, Grey, Green	EA	1	BRL	100	100	10	Yes	282
EPW1464AD-1/2-BOGG-IC	84047	4-14 AWG Stranded Wire, 6-FT, Brown, Orange, Grey, Green	EA	1	BRL	100	100	10	Yes	282
EPW1663AD-1/2-BGG-IC	84051	3-16 AWG Stranded Wire, 6-FT, Brown, Grey, Green	EA	1	BRL	100	100	10	Yes	277
EPW1664AD-1/2-BOGG-IC	84055	4-16 AWG Stranded Wire, 6-FT, Brown, Orange, Grey, Green	EA	1	BRL	100	100	10	Yes	272
EPW1863AD-1/2-BGG-IC	84059	3-18 AWG Stranded Wire, 6-FT, Brown, Grey, Green	EA	1	BRL	100	100	10	Yes	270
EPW1864AD-1/2-BOGG-IC	84063	4-18 AWG Stranded Wire, 6-FT, Brown, Orange, Grey, Green	EA	1	BRL	100	100	10	Yes	277
<b>277 Volt Illumination Control Fixture Whips: 6-Foot, Solid Wire, Die Cast Snap-In Connectors, .5" Conduit</b>										
EPW1263SAD-1/2-BGG-IC	84041	3-12 AWG Solid Wire, 6-FT, Brown, Grey, Green	EA	1	BRL	100	100	10	Yes	292
EPW1463SAD-1/2-BGG-IC	84045	3-14 AWG Solid Wire, 6-FT, Brown, Grey, Green	EA	1	BRL	100	100	10	Yes	282
EPW1464SAD-1/2-BOGG-IC	84049	4-14 AWG Solid Wire, 6-FT, Brown, Orange, Grey, Green	EA	1	BRL	100	100	10	Yes	282
EPW1663SAD-1/2-BGG-IC	84053	3-16 AWG Solid Wire, 6-FT, Brown, Grey, Green	EA	1	BRL	100	100	10	Yes	277
EPW1664SAD-1/2-BOGG-IC	84057	4-16 AWG Solid Wire, 6-FT, Brown, Orange, Grey, Green	EA	1	BRL	100	100	10	Yes	272
EPW1863SAD-1/2-BGG-IC	84061	18 AWG, Brown, Grey, Green	EA	1	BRL	100	100	10	Yes	270
EPW1864SAD-1/2-BOGG-IC	84065	18 AWG, Brown, Orange, Grey, Green	EA	1	BRL	100	100	10	Yes	277

**Note:** All Illumination Control Fixture Whips include two (2) 16 AWG Jacketed Control Wires — Purple and Pink.

#### UNITS OF MEASURE KEY

**Order Unit:** The Unit to be ordered; **Order Qty:** Number of pieces in each Unit; **Unit Pkg:** Packaging types - BG (Bag), BX (Box), BRL (Barrel); **Units/Case:** Unit packages contained in the Case; **TL Case Qty:** The total number of items in each Master Case; **Min Order Qty:** The smallest Unit that can be ordered; **MM Req:** Must order multiples of the Unit in the stated quantities; **Ship Wt (Lbs):** Total weight of the units per Carton

E02-150-014 F1 (02/23 AJ)  
2023 Engineered Products Company. All Rights Reserved.

