

TIGRESS™ Multi-Lamp Temporary Light Fixture

Product Data Sheet

Engineered Products Company's TIGRESS Multi-Lamp Temporary Light Fixture with LED Lamps is a low cost, energy efficient lighting solution that is highly functional for use in low, medium, and high bay lighting applications and a recommended alternative to metal halide luminaires.

Benefits

- Suitable for use in Dry or Damp Environments.
- Multi-Input Voltage Range: 120-277 VAC @ 60/50 Hz.
- Cost effective, virtually no maintenance.
- Compact size and balanced construction for easy handling.
- Pre-installed "Snap-Lock" Hang Hook expedites installation to virtually any structure (e.g., rebar, steel, plastic pipe, or copper tubing).
- For warranty information see page 4 or visit www.engproducts.com.

Features

- Available in six (6) standard configurations with or without an LED Corn Cob Lamp and with or without a Power Cord.
- Rugged and durable steel housing with high-visibility powder coated finish. Includes 11-Gauge Wire Safety Cage.
- Four (4) ½" trade size knockouts on both sides of the power head to provide conduit access and facilitate "daisy-chaining" light fixtures.
- Accommodates any E39 mogul-base self-ballasted lamp.

Note: The intended use lamp must match the voltage! Example: If you select a high lumen LED Lamp for lighting larger spaces such as showrooms, warehouses, and other commercial applications you must ensure the lamp can handle the "selected" voltage. Voltage requirements can be found on the lamp's specifications sheet.

Configurability

EPCO can customize your TIGRESS Multi-Lamp Light Fixture to meet your individual application requirements.

This Fixture is available with or without a power cord. The power cord is a durable and long-lasting 6-foot, 120-Volt 16/3 SJT Power Cord with NEMA 5-15 Plug. Twist-Lock power cord options are available for 120- and 277-volt circuits.

To facilitate "daisy-chaining" from one light fixture to another, use our 15 AMP, 3-foot cord receptacle (Part Number RSS3).

EPCO power cords and receptacle cords are UL Listed and meet the requirements of the 2023 National Electrical Code: Articles 410.62 (B)(C) (1 and 2), and 410.64 Article C, and 410.82.



TIGRESS Multi-Lamp Temporary Light Fixture with 10,000 Lumen LED Lamp (P/N: 15721-10K5)

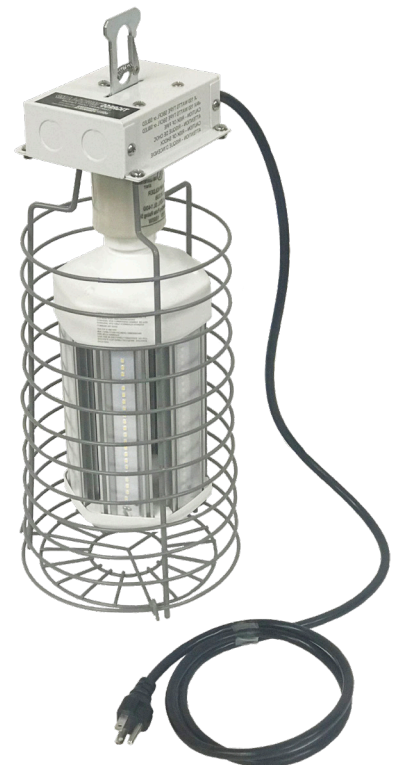

TIGRESS Multi-Lamp Temporary Light Fixture with 10,000 Lumen LED Lamp and 6-Foot Cord (P/N: 15721-10K5-PC6)



SJT 16/3 Round Black Cord: Twist-Lock Plug



SJT 16/3 Round Black Cord: Straight Plug

TIGRESS Multi-Lamp Temporary Light Fixture Specifications

Part Number	Lumens	Watts	Efficacy	Color Temperature	Operating Voltage	Applications	Certifications
Lamped Light Fixtures							
15721-10K5	10,000	100	100	5000K	120-277V AC	Dry or Damp Locations	None
15721-15K5	15,000	125	120	5000K	120-277V AC		
15721-20K5	20,000	175	114	5000K	120-277V AC		
15721-10K5-PC6	10,000	100	100	5000K	120V AC (NEMA 5-15 Plug)		
15721-15K5-PC6	15,000	125	120	5000K	120V AC (NEMA 5-15 Plug)		
15721-20K5-PC6	20,000	175	114	5000K	120V AC (NEMA 5-15 Plug)		
Light Fixtures (No Lamp)							
15721	N/A	N/A	N/A	N/A	120-277V AC		ETL Listed
15721-PC6	N/A	N/A	N/A	N/A	120V AC (NEMA 5-15 Plug)		None

TIGRESS MULTI-LAMP TEMPORARY LIGHT FIXTURE: PART NUMBERS

Catalog Number	UPC Number	Description	Order Unit	Unit Qty	Unit Pkg	Units/Case	TL Case Qty	Min Order Qty	MM Req	Ship Wt (Lbs)
TIGRESS Multi-Lamp Temporary Light Fixtures										
15721	15721	TIGRESS Multi-Lamp Temporary Light Fixture	EA	1	BX	1	1	1	No	6
15721-PC6	15797	TIGRESS Multi-Lamp, with 6-FT SJT 16/3 Cord	EA	1	BX	1	1	1	No	6
15721-10K5	57941	TIGRESS Multi-Lamp, with 10,000 Lumen LED Lamp	EA	1	BX	1	1	1	No	8
15721-15K5	57958	TIGRESS Multi-Lamp, with 15,000 Lumen LED Lamp	EA	1	BX	1	1	1	No	8
15721-20K5	57965	TIGRESS Multi-Lamp, with 20,000 Lumen LED Lamp	EA	1	BX	1	1	1	No	8
15721-10K5-PC6	15791	TIGRESS Multi-Lamp, with 10,000 Lumen LED Lamp and 6-FT SJT 16/3 Cord	EA	1	BX	1	1	1	No	9
15721-15K5-PC6	15792	TIGRESS Multi-Lamp, with 15,000 Lumen LED Lamp and 6-FT SJT 16/3 Cord	EA	1	BX	1	1	1	No	9
15721-20K5-PC6	15793	TIGRESS Multi-Lamp, with 20,000 Lumen LED Lamp and 6-FT SJT 16/3 Cord	EA	1	BX	1	1	1	No	9
Accessories										
PSS3	10186	SJT 16/3 Round Black Cord: 3-FT, Straight Plug, 13 Amp	EA	1	BX	25	25	25	Yes	8
PSS6	10187	SJT 16/3 Round Black Cord: 6-FT, Straight Plug, 13 Amp	EA	1	BX	25	25	25	Yes	12
PSS8	10188	SJT 16/3 Round Black Cord: 8-FT, Straight Plug, 13 Amp	EA	1	BX	25	25	25	Yes	13
RSS3	10219	SJT 16/3 Round Black Receptacle Cord, 15 Amp	EA	1	BX	25	25	25	Yes	12
TL001	10196	SJT 16/3 Round Black Cord: 8-FT, Twist-Lock Plug, 15 Amp, 120-Volt	EA	1	EA	1	1	1	No	2
TL002	10197	SJT 16/3 Round Black Cord: 8-FT, Twist-Lock Plug, 15 Amp, 277-Volt	EA	1	EA	1	1	1	No	2

UNITS OF MEASURE KEY Order Unit: The Unit to be ordered; Unit Qty: Number of pieces in each Unit; Unit Pkg: Unit Packages contained in the case - Packaging types - BG (Bag), BRL (Barrel), BX (Box), BN (Bulk), PKG (Package), EA (Each), RL (Roll), LB (Pound), C (Hundred), M (Thousand); Units/Case: Unit packages contained in the Case; TL Case Qty: The total number of items in each Master Case; Min Order Qty: The smallest Unit that can be ordered; MM Req: Must order multiples of the Unit in the stated quantities; Ship Wt (Lbs): Total weight of the units per Carton

TIGRESS MULTI-LAMP

TIGRESS MULTI-LAMP: DIMENSIONAL REFERENCES

Front View

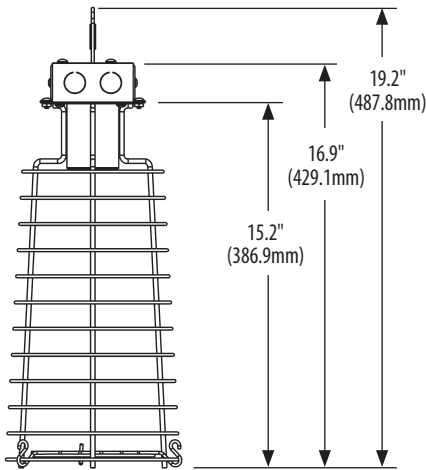

Side View

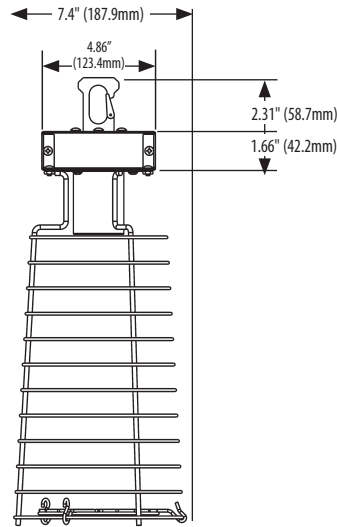

CONFIGURATION EXAMPLES FOR TIGRESS MULTI-LAMP TEMPORARY LIGHT FIXTURE (P/N: 15721)



Grounded NEMA L5-15 Male Plug with NEMA L5-15 Receptacle



Grounded NEMA L5-15 Male Plug



Grounded NEMA L5-15 Male Plug with Romex Cable for Hard Wiring



NEMA 120V or 277V (L5-15P or L7-15P) Twist-Lock Plug with NEMA L5-15 Receptacle (120V only)



NEMA 120V or 277V (L5-15P or L7-15P) Twist-Lock Plug



NEMA 120V or 277V (L5-15P or L7-15P) Twist-Lock Plug with Romex Cable for Hard Wiring



Romex Cable for Hard Wiring



NEMA L5-15 Receptacle with Romex Cable for Hard Wiring

TIGRESS MULTI-LAMP: WARRANTY INFORMATION

Engineered Products Company (herein known as EPCO) warrants at its sole option, after a failure is confirmed as a true defect in materials or workmanship, EPCO will replace or refund, any TIGRESS Multi-Lamp Temporary Light Fixture (herein known as light fixture) for a period of one (1) year from original purchase.

This warranty statement applies to the original purchaser and is not transferable. This Warranty does not apply to any of the following:

- Any Light Fixture that was incorrectly installed by drilling holes, puncturing, piercing or any other means that will alter the product's integrity.
- Damage caused by the use of parts, components, and/or other equipment(s) that is not compatible, suitable, or authorized by EPCO for use with any Light Fixture.
- Damage resulting from the use of any Light Fixture in what EPCO, at its sole discretion, considers extreme applications.
- Product damage as determined by EPCO to be caused by a crash, impact, or obvious signs of abuse to any Light Fixture.
- EPCO is not responsible for "charge-backs" for any type of labor allowance required to remove, re-install, or re-power the Light Fixture and/or the replacement with a Light Fixture.

To obtain a Light Fixture replacement, or to obtain a credit under this warranty, the Purchaser must contact Engineered Products Company within the specified one-year warranty period to obtain a Return Materials Authorization (RMA) form and return shipping instructions for the defective light fixture.

Engineered Products Company shall have no responsibility for any Light Fixture deemed "out of warranty". Under no circumstances shall Engineered Products Company be liable for any loss or damage, whether direct or indirect, incidental, consequential, special or otherwise, arising out of or relating to the use of, or the inability to use the Light Fixture in excess of the cost for replacement of this product proven to be defective during the defined warranty period.

Lamp Warranty: This Lamp(s), has a three (3) year warranty. If this lamp fails or you are not satisfied with its performance after one year, contact Feit Electric directly at info@feit.com or call toll-free 1-866-326-Bulb for instructions on lamp replacement.

Lamp replacement is the sole remedy available and liability for incidental or consequential damage is expressly excluded. Do not return this lamp to the Distributor.

